

**IDEALPLUSING<sup>®</sup>**

## **DC DC Converter**

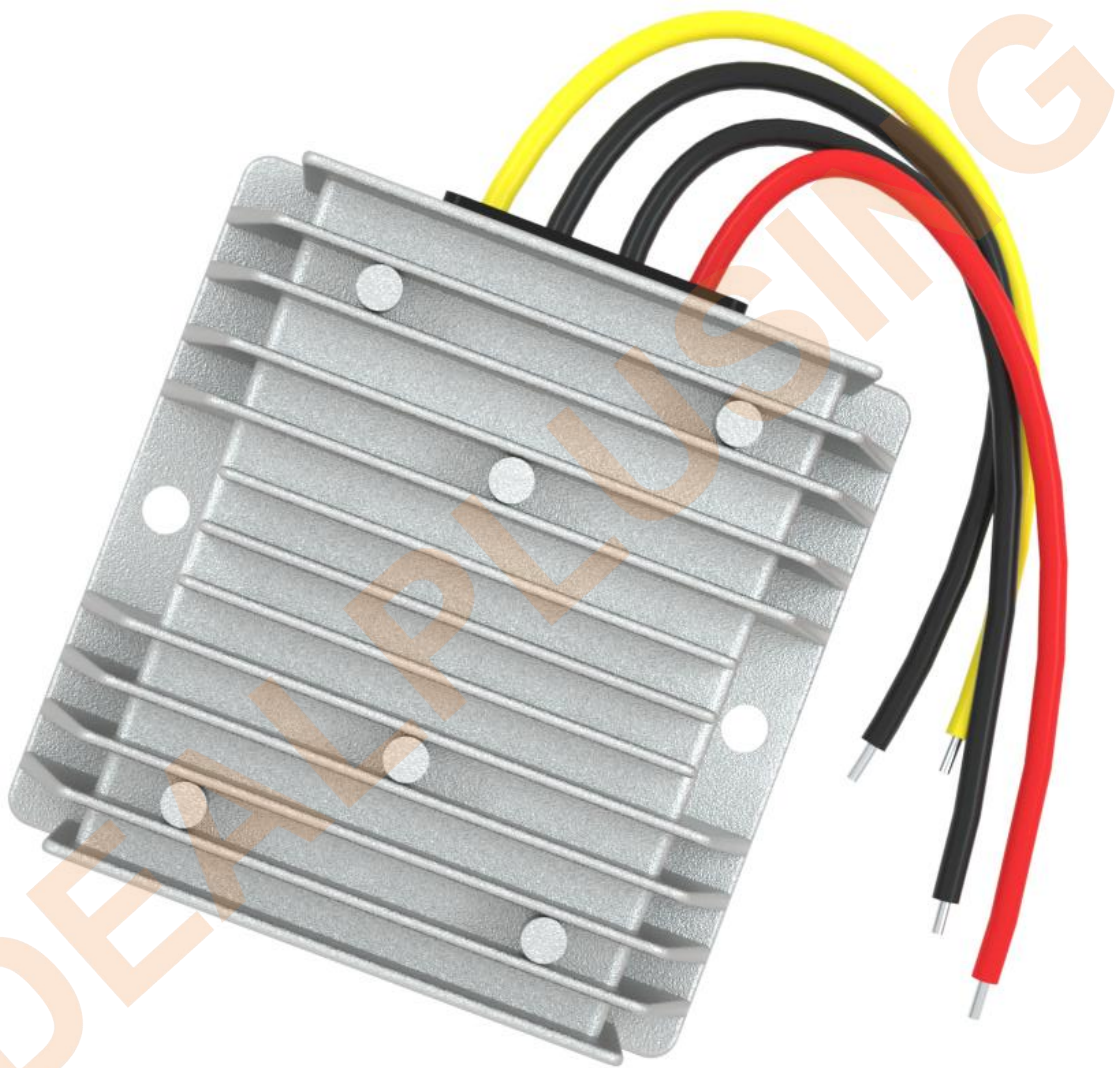

**IPS-DTD72S124**

# Step Down Non Isolate DC DC Converter

# Contents

Main Team .....	1
01 Product Overview .....	1
02 Product Technical Parameters .....	5
03 Model List .....	7
Step Down Non Isolate DC DC Converter Model List .....	8
12VDC/24VDC-5VDC(1~100A) Model List .....	8
24VDC-12VDC(1~200A) Model List .....	9
24VDC-19VDC(1~50A) Model List .....	10
36VDC-5VDC(1~150A) Model List .....	10
36VDC-12VDC(1~150A) Model List .....	11
48VDC-12VDC(1~150A) Model List .....	12
48VDC-24VDC(1~125A) Model List .....	12
48VDC-36VDC(1~40A) Model List .....	13
60VDC-5VDC(1~8A) Model List .....	13
60VDC-12VDC(1~50A) Model List .....	13
60VDC-24VDC(1~40A) Model List .....	14
72VDC-5VDC(1~40A) Model List .....	14
72VDC-12VDC(1~50A) Model List .....	15
84VDC-12VDC(1~50A) Model List .....	15
Boost Non Isolate DC DC Converter Model List .....	15
5VDC-12VDC(1~8A) Model List .....	15
5VDC-15VDC(1~20A) Model List .....	16
6VDC-12VDC(1~20A) Model List .....	16
12VDC-13.8VDC(1~12A) Model List .....	17
12VDC-15VDC(1~12A) Model List .....	17
12VDC-19VDC (1~20A) Model List .....	17
12VDC-24VDC (1~100A) Model List .....	18
12VDC-28VDC (1~100A) Model List .....	18
12VDC-36VDC (1~40A) Model List .....	19
12VDC-48VDC (1~40A) Model List .....	19
12VDC-56VDC/56.4VDC (1~8A) Model List .....	19
12VDC-60VDC (1~3A) Model List .....	19
24VDC-48VDC (1~60A) Model List .....	20

24VDC-72VDC (1~40A) Model List.....	20
48VDC-72VDC (30~45A) Model List.....	21
(6-20VDC)12VDC-12VDC (1~30A) Model List.....	21
<b>Boost &amp; Step Down Non Isolate DC DC Converter Model List.....</b>	<b>21</b>
(6~20VDC)12VDC-12VDC(1~30A) Model List.....	21
(8~40VDC)12VDC/24VDC-12VDC(1~30A) Model List.....	22
(9~36VDC)12VDC/24VDC-12.6VDC(1~20A) ---Lithium Battery Charging Model List.....	22
(6~20VDC)12VDC-13.8VDC(1~30A) Model List.....	22
(8~40VDC)12VDC/24VDC-13.8VDC(1~30A) Model List.....	22
(8~36VDC)12VDC/24VDC-13.8VDC(8A & 20A) Battery Charging Model List.....	23
(8~30VDC)12VDC/24VDC-14.6VDC(3A 8A 12A) Battery Charging Model List.....	23
(9~36VDC)12VDC/24VDC-19VDC(1~15A) Model List.....	23
(8~40VDC)12VDC/24VDC-24VDC(1~20A) Model List.....	23
(18~36VDC)24VDC-24VDC(1~20A) Model List.....	23
(9~36VDC & 18~36VDC)12/24VDC-27VDC 8A &20A) Lithium Battery Charging Model List.....	24
(9~36VDC & 18~36VDC)12/24VDC-28VDC 8A &20A) Battery Charging Model List.....	24
<b>04 Non Standard Customized.....</b>	<b>24</b>
<b>05 Product Wiring.....</b>	<b>29</b>
<b>06 Packaging and Shipping.....</b>	<b>31</b>

---

Thank you for choosing us, we will give you the most satisfactory solution.

# Main Team

## Our Uniqueness

- Dare to innovate
- Never stop pursuing perfection
- Focus on the power supply field
- Actively respond to various challenges



## Our Overseas Sales



**Charis Liu**



**Wechat Code**



**Whatsapp**



**Kim Han**



**Wechat Code**



**Whatsapp**



**Victoria Liu**



**Wechat Code**



**Whatsapp**

# 01

## Product Overview

---

*IDEALPLUSING*

DC DC Converter

# Product Overview

## Features

DC/DC converter is a voltage converter which can effectively output fixed voltage after converting input voltage. DC/DC converters are divided into three categories: Boost type, boost & buck type, and buck type.

Three kinds of control can be adopted according to the demand. PWM control type has high efficiency and good output voltage ripple and noise. PFM control type has the advantage of low power consumption even if it is used for a long time, especially under small load.

PFM control is implemented when PWM/PFM converts to small load, and it is automatically converted to PWM control when heavy load occurs. At present, DC-DC converters are widely used in mobile phones, MP3, digital cameras, portable media players and other products. It belongs to chopper circuit in the classification of circuit types.

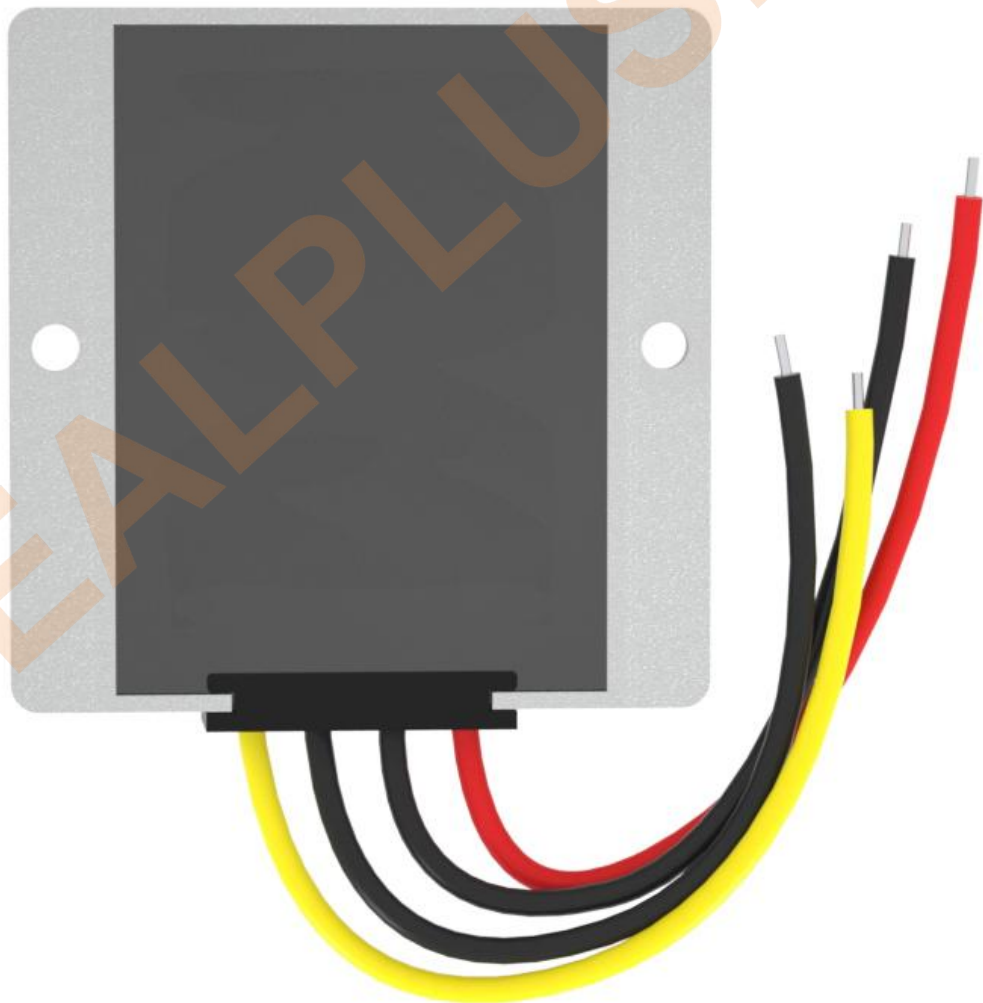

● Design meeting ROHS / CE
● High efficiency: 93%
● Isolated between input and output
● Internal capacitor: NCC & NICHICON (high reliability)
● 100% full load burn-in test
● Over load, Over temperature and Over voltage protections
● Waterproof level IP65
● 12 months warranty

## Model Definition

IPS-DTDXXSYZZZ For example : IPS-DTD12S2460	IPS: IDEALPLUSING Brand
	DTD: DC TO DC
	XXX: Max input Voltage
	YYY: Max output Voltage
	ZZZ: Max output Current

## Application

Our products are designed to suit a variety of loads and scenarios, such as trucks, forklifts, buses, logging trucks, electric motors, telecommunications, ships and yachts, LED markets, etc...



# 02

## Product Technical Parameters

---

*IDEALPLUSING*

DC DC Converter

# Product Technical Parameters

Technical Performance	Technical Index
Brand	IDEALPLUSING
Type	NON-Isolated
Name	Step Down Non Isolate DC DC Converter
Model	IPS-DTD72S124
<b>DC Voltage Input</b>	
Input Voltage rate	72VDC
Input Voltage range	30-90VDC
<b>DC Voltage &amp; Current Output</b>	
Output Voltage rate	12VDC
Output Current	4AMPS
Output Rate Power	48Watts
Converter Size	74*74*32(MM)
NW	/
Customize	Allow
Material of shell	Aluminum
Working temp	-20~80°C
Efficiency	93%
Waterproof Level	IP65
Protection function	Input instant over-voltage Output over current Chip over-heat protection
Customize	From 1-200A Size and weight different if current different

# 03

## Model List

---

*IDEALPLUSING*

DC DC Converter

# Model List

## Step Down Non Isolate DC DC Converter Model List

12VDC/24VDC-5VDC(1~100A)						
Specification	Input Voltage VDC Range	Output Volt VDC	DC Output Current AMP	Max Power WATT	Size (MM) L*H*W	NW/GW (G)
12V/24V-5V 1A	8-32VDC	5VDC	1A	5W	46*27*14	35G/50G
12V/24V-5V 1A	8-30VDC	5VDC	1A	5W	41*21*15	35G/50G
12V/24V-5V 1A	8-40VDC	5VDC	1A	5W	46*32*18	45G/55G
12V/24V-5V 1A	8-40VDC	5VDC	1A	5W	44*24.5*20	45G/55G
12V/24V-5V 1A	8-40VDC	5VDC	1A	5W	44*24.5*20	45G/55G
12V/24V-5V 2A	8-30VDC	5VDC	2A	10W	46*27*14	35G/50G
12V/24V-5V 2A	8-40VDC	5VDC	2A	10W	41*21*15	35G/50G
12V/24V-5V 2A	8-40VDC	5VDC	2A	10W	46*32*18	45G/55G
12V/24V-5V 2A	8-40VDC	5VDC	2A	10W	44*24.5*20	45G/55G
12V/24V-5V 2A	8-40VDC	5VDC	2A	10W	44*24.5*20	45G/55G
12V/24V-5V 3A	8-30VDC	5VDC	3A	15W	46*27*14	35G/50G
12V/24V-5V 3A	8-40VDC	5VDC	3A	15W	46*32*18	45G/55G
12V/24V-5V 3A	8-40VDC	5VDC	3A	15W	41*21*15	35G/50G
12V/24V-5V 3A	8-40VDC	5VDC	3A	15W	44*24.5*20	45G/55G
12V/24V-5V 3A	8-40VDC	5VDC	3A	15W	44*24.5*20	45G/55G
12V/24V-5V 3A	8-32VDC	5VDC	3A	15W	66*57*22	100G/125G
12V/24V-5V 4A	8-40VDC	5VDC	4A	20W	46*32*18	45G/55G
12V/24V-5V 4A	8-40VDC	5VDC	4A	20W	44*24.5*20	45G/55G
12V/24V-5V 5A	8-40VDC	5VDC	5A	25W	46*32*18	45G/55G
12V/24V-5V 5A	8-40VDC	5VDC	5A	25W	44*24.5*20	45G/55G
12V/24V-5V 5A	8-32VDC	5VDC	5A	25W	66*57*22	100G/125G
12V/24V-5V 5A	8-40VDC	5VDC	5A	25W	50*52*15	45G/55G
12V/24V-5V 5A	8-40VDC	5VDC	5A	25W	74*74*32	300G/330G
12V/24V-5V 6A	8-40VDC	5VDC	6A	30W	46*32*18	50G/60G
12V/24V-5V 6A	9-40VDC	5VDC	6A	30W	50*52*15	45G/55G
12V/24V-5V 6A	8-32VDC	5VDC	6A	30W	75*42*18	45G/55G
12V/24V-5V 6A	8-32VDC	5VDC	6A	30W	66*57*22	100G/125G
12V/24V-5V 6A	8-40VDC	5VDC	6A	30W	74*74*32	300G/330G
12V/24V-5V 8A	8-40VDC	5VDC	8A	40W	46*32*18	50G/60G
12V/24V-5V 8A	9-40VDC	5VDC	8A	40W	50*52*15	45G/55G
12V/24V-5V 8A	8-32VDC	5VDC	8A	40W	75*42*18	45G/55G
12V/24V-5V 8A	8-32VDC	5VDC	8A	40W	66*57*22	100G/125G
12V/24V-5V 8A	8-40VDC	5VDC	8A	40W	74*74*32	300G/330G
12V/24V-5V 10A	8-32VDC	5VDC	10A	50W	75*42*18	50G/60G
12V/24V-5V 10A	8-32VDC	5VDC	10A	50W	66*57*22	100G/125G
12V/24V-5V 10A	8-40VDC	5VDC	10A	50W	74*74*32	300G/330G

12V/24V-5V 15A	8-32VDC	5VDC	15A	75W	74*74*32	300G/330G
12V/24V-5V 20A	8-32VDC	5VDC	20A	100W	74*74*32	300G/330G
12V/24V-5V 25A	8-32VDC	5VDC	25A	125W	74*74*32	300G/330G
12V/24V-5V 30A	8~40VDC	5VDC	30A	150W	74*74*32	300G/330G
12V/24V-5V 40A	8-32VDC	5VDC	40A	200W	100*80*39	500G/550G
12V/24V-5V 50A	8-32VDC	5VDC	50A	250W	100*80*39	500G/550G
12V/24V-5V 60A	8-32VDC	5VDC	60A	300W	150*127*63	1600G/1800G
12V/24V-5V 100A	8-32VDC	5VDC	100A	500W	150*130*50	2500G/3000G

24VDC-12VDC(1~200A)						
Specification	Input Voltage VDC Range	Output Volt VDC	DC Output Current AMP	Max Power WATT	Size (MM) L*H*W	NW/GW (G)
24VDC-12VDC 3A	15-32VDC	12VDC	3A	36W	44*24.5*20	45G/55G
24VDC-12VDC 3A	15-32VDC	12VDC	3A	36W	46*27*14	45G/55G
24VDC-12VDC 3A	15-32VDC	12VDC	3A	36W	46*32*18	45G/55G
24VDC-12VDC 3A	15-32VDC	12VDC	3A	36W	44*24.5*20 Gold Color	45G/55G
24VDC-12VDC 3A	15-36VDC	12VDC	3A	36W	46*27*14	45G/55G
24VDC-12VDC 3.5A	15-36VDC	12VDC	3.5	42W	46*32*18	45G/55G
24VDC-12VDC 5A	15-36VDC	12VDC	5A	60W	46*32*18	45G/55G
24VDC-12VDC 5A	15-36VDC	12VDC	5A	60W	25*52*15	65G/75G
24VDC-12VDC 5A	15-40VDC	12VDC	5A	60W	46*32*18	45G/55G
24VDC-12VDC 5A	15-40VDC	12VDC	5A	60W	44*24.5*20	45G/55G
24VDC-12VDC 5A	15-40VDC	12VDC	5A	60W	44*24.5*20	45G/55G
24VDC-12VDC 5A	15-40VDC	12VDC	5A	60W	66*57*22	100G/125G
24VDC-12VDC 5A	15-40VDC	12VDC	5A	60W	50*52*15	45G/55G
24VDC-12VDC 10A	18~32VDC	12VDC	10A	120W	75*42*18	45G/55G
24VDC-12VDC 10A	15-40VDC	12VDC	10A	120W	50*52*15	45G/55G
24VDC-12VDC 10A	18~32VDC	12VDC	10A	120W	66*57*22	100G/125G
24VDC-12VDC 10A	18~32VDC	12VDC	10A	120W	74*74*32	300G/330G
24VDC-12VDC 12A	18~32VDC	12VDC	12A	144W	74*74*32	300G/330G
24VDC-12VDC 15A	18~32VDC	12VDC	15A	180W	74*74*32	300G/330G
24VDC-12VDC 18A	18~32VDC	12VDC	18A	216W	74*74*32	300G/330G
24VDC-12VDC 20A	18~32VDC	12VDC	20A	240W	74*74*32	300G/330G
24VDC-12VDC 22A	15-40VDC	12VDC	22A	264W	74*74*32	300G/330G
24VDC-12VDC 25A	15-40VDC	12VDC	25A	300W	74*74*32	300G/330G
24VDC-12VDC 28A	15-40VDC	12VDC	28A	336W	74*74*32	300G/330G
24VDC-12VDC 30A	15-40VDC	12VDC	30A	360W	74*74*32	300G/330G
24VDC-12VDC 30A	15-30VDC	12VDC	30A	360W	100*80*39	500G/550G
24VDC-12VDC 40A	18~32VDC	12VDC	40A	480W	100*80*39	500G/550G
24VDC-12VDC 40A	18~32VDC	12VDC	40A	480W	108*80*45	700G/900G
24VDC-12VDC 50A	18~32VDC	12VDC	50A	600W	150*127*63	1600G/1800G
24VDC-12VDC 60A	18~32VDC	12VDC	60A	720W	150*127*63	1600G/1800G

24VDC-12VDC 60A	18~32VDC	12VDC	60A	720W	160*113*35	1600G/1800G
24VDC-12VDC 85A	18~32VDC	12VDC	85A	1020W	220*127*63	2500G/3000G
24VDC-12VDC 100A	18~32VDC	12VDC	100A	1200W	220*127*63	2500G/3000G
24VDC-12VDC 120A	18~32VDC	12VDC	120A	1440W	300*127*63	3500G/4000G
24VDC-12VDC 150A	18~32VDC	12VDC	150A	1800W	220*156*65	7000G/8000G
24VDC-12VDC 150A	18~32VDC	12VDC	165A	1980W	220*156*65	7000G/8000G
24VDC-12VDC 200A	18~32VDC	12VDC	200A	2400W	220*156*65	3700G/4500G

24VDC-19VDC(1~50A)						
Specification	Input Voltage VDC Range	Output Volts VDC	DC Output Current AMP	Max Power WATT	Size (MM) L*H*W	NW/GW (G)
24VDC-19VDC 1A	18-40VDC	19VDC	1A	19W	46*32*18	45G/55G
24VDC-19VDC 1A	18-40VDC	19VDC	1A	19W	44*24.5*20	45G/55G
24VDC-19VDC 1A	18-40VDC	19VDC	1A	19W	44*24.5*20	45G/55G
24VDC-19VDC 2A	18-40VDC	19VDC	2A	38W	46*32*18	45G/55G
24VDC-19VDC 2A	18-40VDC	19VDC	2A	38W	44*24.5*20	45G/55G
24VDC-19VDC 2A	18-40VDC	19VDC	2A	38W	44*24.5*20	45G/55G
24VDC-19VDC 3A	18-40VDC	19VDC	3A	57W	46*32*18	45G/55G
24VDC-19VDC 3A	18-40VDC	19VDC	3A	57W	44*24.5*20	45G/55G
24VDC-19VDC 3A	18-40VDC	19VDC	3A	57W	44*24.5*20	45G/55G
24VDC-19VDC 4A	18-40VDC	19VDC	4A	76W	46*32*18	45G/55G
24VDC-19VDC 4A	18-40VDC	19VDC	4A	76W	44*24.5*20	45G/55G
24VDC-19VDC 4A	18-40VDC	19VDC	4A	76W	44*24.5*20	45G/55G
24VDC-19VDC 5A	18-40VDC	19VDC	5A	94W	46*32*18	45G/55G
24VDC-19VDC 5A	18-40VDC	19VDC	5A	94W	44*24.5*20	45G/55G
24VDC-19VDC 5A	18-40VDC	19VDC	5A	94W	44*24.5*20	45G/55G
24VDC-19VDC 10A	18-40VDC	19VDC	10A	190W	74*74*32	300G/330G
24VDC-19VDC 15A	18-40VDC	19VDC	15A	285W	74*74*32	300G/330G
24VDC-19VDC 20A	18-40VDC	19VDC	20A	380W	74*74*32	300G/330G
24VDC-19VDC 25A	18-40VDC	19VDC	25A	475W	74*74*32	300G/330G
24VDC-19VDC 30A	18-40VDC	19VDC	30A	570W	100*80*39	500G/550G
24VDC-19VDC 35A	18-40VDC	19VDC	35A	665W	100*80*39	500G/550G

36VDC-5VDC(1~150A)						
Specification	Input Voltage VDC Range	Output Volts VDC	DC Output Current AMP	Max Power WATT	Size (MM) L*H*W	NW/GW (G)
24VDC-19VDC 1A	18-40VDC	19VDC	1A	19W	46*32*18	45G/55G
24VDC-19VDC 1A	18-40VDC	19VDC	1A	19W	44*24.5*20	45G/55G
24VDC-19VDC 1A	18-40VDC	19VDC	1A	19W	44*24.5*20	45G/55G
24VDC-19VDC 2A	18-40VDC	19VDC	2A	38W	46*32*18	45G/55G
24VDC-19VDC 2A	18-40VDC	19VDC	2A	38W	44*24.5*20	45G/55G
24VDC-19VDC 2A	18-40VDC	19VDC	2A	38W	44*24.5*20	45G/55G
24VDC-19VDC 3A	18-40VDC	19VDC	3A	57W	46*32*18	45G/55G
24VDC-19VDC 3A	18-40VDC	19VDC	3A	57W	44*24.5*20	45G/55G

24VDC-19VDC 3A	18-40VDC	19VDC	3A	57W	44*24.5*20	45G/55G
24VDC-19VDC 4A	18-40VDC	19VDC	4A	76W	46*32*18	45G/55G
24VDC-19VDC 4A	18-40VDC	19VDC	4A	76W	44*24.5*20	45G/55G
24VDC-19VDC 4A	18-40VDC	19VDC	4A	76W	44*24.5*20	45G/55G
24VDC-19VDC 5A	18-40VDC	19VDC	5A	94W	46*32*18	45G/55G
24VDC-19VDC 5A	18-40VDC	19VDC	5A	94W	44*24.5*20	45G/55G
24VDC-19VDC 5A	18-40VDC	19VDC	5A	94W	44*24.5*20	45G/55G
24VDC-19VDC 10A	18-40VDC	19VDC	10A	190W	74*74*32	300G/330G
24VDC-19VDC 15A	18-40VDC	19VDC	15A	285W	74*74*32	300G/330G
24VDC-19VDC 20A	18-40VDC	19VDC	20A	380W	74*74*32	300G/330G
24VDC-19VDC 25A	18-40VDC	19VDC	25A	475W	74*74*32	300G/330G
24VDC-19VDC 30A	18-40VDC	19VDC	30A	570W	100*80*39	500G/550G
24VDC-19VDC 35A	18-40VDC	19VDC	35A	665W	100*80*39	500G/550G

36VDC-12VDC(1~150A)						
Specification	Input Voltage VDC Range	Output Volts VDC	DC Output Current AMP	Max Power WATT	Size (MM) L*H*W	NW/GW (G)
24/36/48VDC-12VDC 1A	8-60VDC	12VDC	1A	12W	46*32*18	45G/55G
24/36/48VDC-12VDC 1A	9-60VDC	12VDC	1A	12W	50*52*15	70G/85G
24/36/48VDC-12VDC 1A	8-60VDC	12VDC	1A	12W	44*24.5*20	45G/55G
24/36/48VDC-12VDC 2A	8-60VDC	12VDC	2A	24W	46*32*18	45G/55G
24/36/48VDC-12VDC 2A	8-60VDC	12VDC	2A	24W	44*24.5*20	45G/55G
24/36/48VDC-12VDC 3A	8-60VDC	12VDC	3A	36W	46*32*18	45G/55G
24/36/48VDC-12VDC 8A	9-60VDC	12VDC	3A	36W	50*52*15	70G/85G
24/36/48VDC-12VDC 3A	8-60VDC	12VDC	3A	36W	44*24.5*20	45G/55G
24/36/48VDC-12VDC 3A	9-60VDC	12VDC	3A	36W	58*40*22	97G/110G
24/36/48VDC-12VDC 8A	9-60VDC	12VDC	5A	60W	50*52*15	70G/85G
24/36/48VDC-12VDC 5A	9-60VDC	12VDC	5A	60W	58*40*22	97G/110G
24/36/48VDC-12VDC 6A	9-60VDC	12VDC	6A	72W	58*40*22	97G/110G
24/36/48VDC-12VDC 7A	9-60VDC	12VDC	7A	84W	58*40*22	97G/110G
24/36/48VDC-12VDC 8A	9-60VDC	12VDC	8A	96W	58*40*22	97G/110G
24/36/48VDC-12VDC 8A	9-60VDC	12VDC	8A	96W	66*57*22	100G/125G
24/36/48VDC-12VDC 10A	9-60VDC	12VDC	10A	120W	66*57*22	100G/125G
24/36/48VDC-12VDC 10A	20-80VDC	12VDC	10A	120W	74*74*32	300G/330G
24/36/48VDC-12VDC 15A	20-80VDC	12VDC	15A	180W	74*74*32	300G/330G
24/36/48VDC-12VDC 20A	30-60VDC	12VDC	20A	240W	74*74*32	300G/330G
24/36/48VDC-12VDC 20A	30-60VDC	12VDC	20A	240W	100*80*39	500G/550G
24/36/48VDC-12VDC 25A	30-60VDC	12VDC	25A	300W	100*80*39	500G/550G
24/36/48VDC-12VDC 30A	30-60VDC	12VDC	30A	360W	100*80*39	500G/550G
36/48VDC-12VDC 40A	30-60VDC	12VDC	40A	480W	100*113*35	700G/900G
36/48VDC-12VDC 50A	30-60VDC	12VDC	50A	600W	150*127*63	1600G/1800G
36/48VDC-12VDC 60A	30-60VDC	12VDC	60A	720W	150*127*63	1600G/1800G
36/48VDC-12VDC 80A	30-60VDC	12VDC	80A	960W	220*130*50	2500G/3000G

36/48VDC-12VDC 100A	30-60VDC	12VDC	100A	1200W	220*130*50	2500G/3000G
36/48VDC-12VDC 150A	30-60VDC	12VDC	150A	1800W	220*156*65	3500G/4000G

48VDC-12VDC(1~150A)						
Specification	Input Voltage VDC Range	Output Volts VDC	DC Output Current AMP	Max Power WATT	Size (MM) L*H*W	NW/GW (G)
24/36/48VDC-12VDC 1A	15-58VDC	12VDC	1A	12W	46*32*18	45G/55G
24/36/48VDC-12VDC 1A	15-58VDC	12VDC	1A	12W	44*24.5*20	45G/55G
24/36/48VDC-12VDC 1A	15-58VDC	12VDC	1A	12W	44*24.5*20	45G/55G
24/36/48VDC-12VDC 2A	15-58VDC	12VDC	2A	24W	46*32*18	45G/55G
24/36/48VDC-12VDC 2A	15-58VDC	12VDC	2A	24W	44*24.5*20	45G/55G
24/36/48VDC-12VDC 2A	15-58VDC	12VDC	2A	24W	44*24.5*20	45G/55G
24/36/48VDC-12VDC 3A	15-58VDC	12VDC	3A	36W	46*32*18	45G/55G
24/36/48VDC-12VDC 3A	15-58VDC	12VDC	3A	36W	44*24.5*20	45G/55G
24/36/48VDC-12VDC 3A	15-58VDC	12VDC	3A	36W	44*24.5*20	45G/55G
36/48VDC-12VDC 3A	30-60VDC	12VDC	3A	36W	66*57*22	100G/125G
36/48VDC-12VDC 5A	30-60VDC	12VDC	5A	60W	66*57*22	100G/125G
24/36/48VDC-12VDC 6A	20-60VDC	12VDC	6A	72W	66*57*22	100G/125G
24/36/48VDC-12VDC 8A	20-60VDC	12VDC	8A	96W	58*40*22	100G/125G
24/36/48VDC-12VDC 8A	20-60VDC	12VDC	8A	96W	66*57*22	100G/125G
24/36/48VDC-12VDC 10A	20-60VDC	12VDC	10A	120W	58*40*22	100G/125G
36/48VDC-12VDC 10A	30-60VDC	12VDC	10A	120W	74*74*32	300G/330G
36/48VDC-12VDC 15A	30-60VDC	12VDC	15A	180W	74*74*32	300G/330G
36/48VDC-12VDC 20A	30-60VDC	12VDC	20A	240W	74*74*32	300G/330G
36/48VDC-12VDC 25A	30-60VDC	12VDC	25A	300W	100*80*39	500G/550G
36/48VDC-12VDC 30A	30-60VDC	12VDC	30A	360W	100*80*39	500G/550G
36/48VDC-12VDC 40A	30-60VDC	12VDC	40A	480W	100*113*35	700G/900G
36/48VDC-12VDC 50A	30-60VDC	12VDC	50A	600W	150*127*63	1600G/1800G
36/48VDC-12VDC 60A	30-60VDC	12VDC	60A	720W	150*127*63	1600G/1800G
36/48VDC-12VDC 100A	30-60VDC	12VDC	100A	1200W	220*130*50	2500G/3000G
36/48VDC-12VDC 150A	30-60VDC	12VDC	150A	1800W	220*156*65	3500G/4000G

48VDC-24VDC(1~125A)						
Specification	Input Voltage VDC Range	Output Volts VDC	DC Output Current AMP	Max Power WATT	Size (MM) L*H*W	NW/GW (G)
36/48VDC-24VDC 1A	30-60VDC	24VDC	1A	24W	46*32*18	45G/55G
36/48VDC-24VDC 1A	30-60VDC	24VDC	1A	24W	44*24.5*20	45G/55G
36/48VDC-24VDC 2A	30-60VDC	24VDC	2A	48W	66*57*22	100G/125G
36/48VDC-24VDC 2A	30-60VDC	24VDC	2A	48W	44*24.5*20	45G/55G
36/48VDC-24VDC 3A	30-60VDC	24VDC	3A	72W	58*40*22	100G/125G
36/48VDC-24VDC 3A	30-60VDC	24VDC	3A	72W	66*57*22	100G/125G
36/48VDC-24VDC 4A	30-60VDC	24VDC	4A	96W	58*40*22	100G/125G
36/48VDC-24VDC 4A	30-60VDC	24VDC	4A	96W	66*57*22	100G/125G
36/48VDC-24VDC 5A	30-60VDC	24VDC	5A	120W	58*40*22	100G/125G



36/48VDC-24VDC 5A	30-60VDC	24VDC	5A	120W	66*57*22	100G/125G
36/48VDC-24VDC 5A	30-60VDC	24VDC	5A	120W	74*74*32	300G/330G
36/48VDC-24VDC 6A	30-60VDC	24VDC	6A	144W	66*57*22	100G/125G
36/48VDC-24VDC 6A	30-60VDC	24VDC	6A	144W	66*57*22	100G/125G
36/48VDC-24VDC 6A	30-60VDC	24VDC	6A	144W	74*74*32	300G/330G
36/48VDC-24VDC 10A	30-60VDC	24VDC	10A	240W	74*74*32	300G/330G
36/48VDC-24VDC 15A	30-60VDC	24VDC	15A	384W	74*74*32	300G/330G
36/48VDC-24VDC 20A	30-60VDC	24VDC	20A	480W	100*80*39	500G/550G
36/48VDC-24VDC 30A	30-60VDC	24VDC	30A	720W	100*80*39	500G/550G
36/48VDC-24VDC 40A	30-60VDC	24VDC	40A	960W	150*127*63	1600G/1800G
36/48VDC-24VDC 50A	30-60VDC	24VDC	50A	1200W	220*127*63	2500G/3000G
36/48VDC-24VDC 60A	30-60VDC	24VDC	60A	1440W	220*127*63	2500G/3000G
36/48VDC-24VDC 80A	30-60VDC	24VDC	80A	1920W	220*130*50	2500G/3000G
36/48VDC-24VDC 100A	30-60VDC	24VDC	100A	2400W	220*130*50	2500G/3000G
36/48VDC-24VDC 125A	30-60VDC	24VDC	125A	3000W	220*156*65	3300G/3500G

#### 48VDC-36VDC(1~40A)

Specification	Input Voltage VDC Range	Output Volts VDC	DC Output Current AMP	Max Power WATT	Size (MM) L*H*W	NW/GW (G)
48VDC-36VDC 1A	40~60VDC	36VDC	1A	36W	58*40*22	100G/125G
48VDC-36VDC 2A	40~60VDC	36VDC	2A	72W	58*40*22	100G/125G
48VDC-36VDC 3A	40~60VDC	36VDC	3A	108W	58*40*22	100G/125G
48VDC-36VDC 4A	40~60VDC	36VDC	4A	144W	74*74*32	300G/330G
48VDC-36VDC 5A	40~60VDC	36VDC	5A	180W	74*74*32	300G/330G
48VDC-36VDC 6A	40~60VDC	36VDC	6A	216W	74*74*32	300G/330G
48VDC-36VDC 8A	40~60VDC	36VDC	8A	288W	74*74*32	300G/330G

#### 60VDC-5VDC(1~8A)

Specification	Input Voltage VDC Range	Output Volts VDC	DC Output Current AMP	Max Power WATT	Size (MM) L*H*W	NW/GW (G)
12/24/36/48/60VDC-5VDC 1A	8~72VDC	5VDC	1A	5W	74*74*32	300G/330G
12/24/36/48/60VDC-5VDC 2A	8~72VDC	5VDC	2A	10W	74*74*32	300G/330G
12/24/36/48/60VDC-5VDC 3A	8~72VDC	5VDC	3A	15W	74*74*32	300G/330G
12/24/36/48/60VDC-5VDC 4A	8~72VDC	5VDC	4A	20W	74*74*32	300G/330G
12/24/36/48/60VDC-5VDC 5A	8~72VDC	5VDC	5A	25W	74*74*32	300G/330G
12/24/36/48/60VDC-5VDC 6A	8~72VDC	5VDC	6A	30W	74*74*32	300G/330G
12/24/36/48/60VDC-5VDC 8A	8~72VDC	5VDC	8A	40W	74*74*32	300G/330G
12/24/36/48/60VDC-5VDC 10A	8~72VDC	5VDC	10A	50W	74*74*32	300G/330G
12/24/36/48/60VDC-5VDC 12A	8~72VDC	5VDC	12A	60W	74*74*32	300G/330G
12/24/36/48/60VDC-5VDC 15A	8~72VDC	5VDC	15A	75W	74*74*32	300G/330G
12/24/36/48/60VDC-5VDC 18A	8~72VDC	5VDC	18A	90W	74*74*32	300G/330G

#### 60VDC-12VDC(1~50A)

Specification	Input Voltage	Output Volts	DC Output	Max Power	Size (MM)	NW/GW
---------------	---------------	--------------	-----------	-----------	-----------	-------

	VDC Range	VDC	Current AMP	WATT	L*H*W	(G)
48/60/72/84VDC-12VDC 1A	40~90VDC	12VDC	1A	12W	74*74*32	300G/330G
48/60/72/84VDC-12VDC 2A	40~90VDC	12VDC	2A	24W	74*74*32	300G/330G
48/60/72/84VDC-12VDC 3A	40~90VDC	12VDC	3A	36W	74*74*32	300G/330G
48/60/72/84VDC-12VDC 4A	40~90VDC	12VDC	4A	48W	74*74*32	300G/330G
48/60/72/84VDC-12VDC 5A	40~90VDC	12VDC	5A	60W	74*74*32	300G/330G
48/60/72/84VDC-12VDC 6A	40~90VDC	12VDC	6A	72W	74*74*32	300G/330G
48/60/72/84VDC-12VDC 8A	40~90VDC	12VDC	8A	96W	74*74*32	300G/330G
48/60/72/84VDC-12VDC 10A	40~90VDC	12VDC	10A	120W	74*74*32	300G/330G
48/60/72/84VDC-12VDC 15A	40~90VDC	12VDC	15A	180W	100*80*39	500G/550G
48/60/72/84VDC-12VDC 20A	40~90VDC	12VDC	20A	240W	100*80*39	500G/550G
48/60/72/84VDC-12VDC 20A	40~90VDC	12VDC	20A	240W	100*113*35	700G/900G
48/60/72/84VDC-12VDC 30A	40~90VDC	12VDC	30A	360W	100*113*35	700G/900G
48/60/72/84VDC-12VDC 40A	40~90VDC	12VDC	40A	480W	160*113*35	1500G/2000G

60VDC-24VDC(1~40A)						
Specification	Input Voltage VDC Range	Output Volts VDC	DC Output Current AMP	Max Power WATT	Size (MM) L*H*W	NW/GW (G)
36/48/60VDC-24VDC 1A	30-72VDC	24VDC	1A	24W	74*74*32	300G/330G
36/48/60VDC-24VDC 2A	30-72VDC	24VDC	2A	48W	74*74*32	300G/330G
36/48/60VDC-24VDC 3A	30-72VDC	24VDC	3A	72W	74*74*32	300G/330G
36/48/60VDC-24VDC 4A	30-72VDC	24VDC	4A	96W	74*74*32	300G/330G
36/48/60VDC-24VDC 5A	30-72VDC	24VDC	5A	120W	74*74*32	300G/330G
36/48/60VDC-24VDC 6A	30-72VDC	24VDC	6A	144W	74*74*32	300G/330G
36/48/60VDC-24VDC 8A	30-72VDC	24VDC	8A	192W	74*74*32	300G/330G
36/48/60VDC-24VDC 10A	30-72VDC	24VDC	10A	240W	74*74*32	300G/330G
36/48/60VDC-24VDC 12A	30-72VDC	24VDC	12A	288W	74*74*32	300G/330G
48/60/72/84VDC-24VDC 15A	40~90VDC	24VDC	15A	360W	100*80*39	500G/550G
48/60/72/84VDC-24VDC 20A	40~90VDC	24VDC	20A	480W	100*80*39	500G/550G
48/60/72/84VDC-24VDC 30A	40~90VDC	24VDC	30A	720W	160*113*35	1500G/2000G
48/60/72/84VDC-24VDC 40A	40~90VDC	24VDC	40A	960W	150*130*50	1500G/2000G

72VDC-5VDC(1~40A)						
Specification	Input Voltage VDC Range	Output Volts VDC	DC Output Current AMP	Max Power WATT	Size (MM) L*H*W	NW/GW (G)
12/24/36/48/60/72/84VDC-5VDC 1A	8-90VDC	5VDC	1A	5W	74*74*32	300G/330G
12/24/36/48/60/72/84VDC-5VDC 2A	8-90VDC	5VDC	2A	10W	74*74*32	300G/330G
12/24/36/48/60/72/84VDC-5VDC 3A	8-90VDC	5VDC	3A	15W	74*74*32	300G/330G
12/24/36/48/60/72/84VDC-5VDC 4A	8-90VDC	5VDC	4A	20W	74*74*32	300G/330G
12/24/36/48/60/72/84VDC-5VDC 5A	8-90VDC	5VDC	5A	25W	74*74*32	300G/330G
12/24/36/48/60/72/84VDC-5VDC 6A	8-90VDC	5VDC	6A	30W	74*74*32	300G/330G
12/24/36/48/60/72/84VDC-5VDC 8A	8-90VDC	5VDC	8A	40W	74*74*32	300G/330G

72VDC-12VDC(1~50A)						
Specification	Input Voltage VDC Range	Output Volts VDC	DC Output Current AMP	Max Power WATT	Size (MM) L*H*W	NW/GW (G)
48/60/72/84VDC-12VDC 1A	30~90VDC	12VDC	1A	12W	74*74*32	300G/330G
48/60/72/84VDC-12VDC 2A	30~90VDC	12VDC	2A	24W	74*74*32	300G/330G
48/60/72/84VDC-12VDC 3A	30~90VDC	12VDC	3A	36W	74*74*32	300G/330G
48/60/72/84VDC-12VDC 4A	30~90VDC	12VDC	4A	48W	74*74*32	300G/330G
48/60/72/84VDC-12VDC 5A	30~90VDC	12VDC	5A	60W	74*74*32	300G/330G
48/60/72/84VDC-12VDC 6A	30~90VDC	12VDC	6A	72W	74*74*32	300G/330G
48/60/72/84VDC-12VDC 8A	30~90VDC	12VDC	8A	96W	74*74*32	300G/330G
48/60/72/84VDC-12VDC 10A	30~90VDC	12VDC	10A	120W	74*74*32	300G/330G
48/60/72/84VDC-12VDC 15A	30~90VDC	12VDC	15A	180W	100*80*39	500G/550G
48/60/72/84VDC-12VDC 20A	30~90VDC	12VDC	20A	240W	100*80*39	500G/550G
48/60/72/84VDC-12VDC 20A	30~90VDC	12VDC	20A	240W	100*113*35	700G/900G
48/60/72/84VDC-12VDC 30A	30~90VDC	12VDC	30A	360W	100*113*35	700G/900G
48/60/72/84VDC-12VDC 40A	30~90VDC	12VDC	40A	480W	160*113*35	1500G/2000G

84VDC-12VDC(1~50A)						
Specification	Input Voltage VDC Range	Output Volts VDC	DC Output Current AMP	Max Power WATT	Size (MM) L*H*W	NW/GW (G)
48/60/72/84VDC-12VDC 1A	30~90VDC	12VDC	1A	12W	74*74*32	300G/330G
48/60/72/84VDC-12VDC 2A	40~90VDC	12VDC	2A	24W	74*74*32	300G/330G
48/60/72/84VDC-12VDC 3A	40~90VDC	12VDC	3A	36W	74*74*32	300G/330G
48/60/72/84VDC-12VDC 4A	40~90VDC	12VDC	4A	48W	74*74*32	300G/330G
48/60/72/84VDC-12VDC 5A	40~90VDC	12VDC	5A	60W	74*74*32	300G/330G
48/60/72/84VDC-12VDC 6A	40~90VDC	12VDC	6A	72W	74*74*32	300G/330G
48/60/72/84VDC-12VDC 8A	40~90VDC	12VDC	8A	96W	74*74*32	300G/330G
48/60/72/84VDC-12VDC 10A	30~90VDC	12VDC	10A	120W	74*74*32	300G/330G
48/60/72/84VDC-12VDC 10A	20~96VDC	12VDC	10A	120W	74*74*32	300G/330G
48/60/72/84VDC-12VDC 15A	40~90VDC	12VDC	15A	180W	100*80*39	500G/550G
48/60/72/84VDC-12VDC 20A	40~90VDC	12VDC	20A	240W	100*80*39	500G/550G
48/60/72/84VDC-12VDC 20A	40~90VDC	12VDC	20A	240W	100*113*35	700G/900G
48/60/72/84VDC-12VDC 30A	40~90VDC	12VDC	30A	360W	100*113*35	700G/900G
48/60/72/84VDC-12VDC 40A	40~90VDC	12VDC	40A	480W	160*113*35	1500G/2000G
48/60/72/84VDC-12VDC 50A	30~90VDC	12VDC	50A	600W	220*130*50	2500G/3000G

### Boost Non Isolate DC DC Converter Model List

5VDC-12VDC(1~8A)						
Specification	Input Voltage VDC Range	Output Volts VDC	DC Output Current AMP	Max Power WATT	Size (MM) L*H*W	NW/GW (G)
5VDC-12VDC 1A	5~11VDC	12VDC	1A	12W	58*40*22	100G/125G
5VDC-12VDC 1A	5~11VDC	12VDC	1A	12W	66*57*22	100G/125G
5VDC-12VDC 2A	5~11VDC	12VDC	2A	24W	58*40*22	100G/125G
5VDC-12VDC 2A	5~11VDC	12VDC	2A	24W	66*57*22	100G/125G

5VDC-12VDC 3A	5~11VDC	12VDC	3A	36W	58*40*22	100G/125G
5VDC-12VDC 3A	5~11VDC	12VDC	3A	36W	66*57*22	100G/125G
5VDC-12VDC 4A	5~11VDC	12VDC	4A	48W	58*40*22	100G/125G
5VDC-12VDC 5A	5~11VDC	12VDC	5A	60W	74*74*32	300G/330G
5VDC-12VDC 6A	5~11VDC	12VDC	6A	72W	74*74*32	300G/330G
5VDC-12VDC 8A	5~11VDC	12VDC	8A	96W	74*74*32	300G/330G

#### 5VDC-15VDC(1~20A)

Specification	Input Voltage VDC Range	Output Volts VDC	DC Output Current AMP	Max Power WATT	Size (MM) L*H*W	NW/GW (G)
5VDC-15VDC 1A	9~14VDC	15VDC	1A	15W	66*57*22	100G/125G
5VDC-15VDC 2A	9~14VDC	15VDC	2A	30W	66*57*22	100G/125G
5VDC-15VDC 3A	9~14VDC	15VDC	3A	45W	66*57*22	100G/125G
5VDC-15VDC 4A	9~14VDC	15VDC	4A	60W	74*74*32	300G/330G
5VDC-15VDC 5A	9~14VDC	15VDC	5A	75W	74*74*32	300G/330G
5VDC-15VDC 6A	9~14VDC	15VDC	6A	90W	74*74*32	300G/330G
5VDC-15VDC 8A	9~14VDC	15VDC	8A	120W	74*74*32	300G/330G
5VDC-15VDC 10A	9~14VDC	15VDC	10A	150W	74*74*32	300G/330G
5VDC-15VDC 12A	9~14VDC	15VDC	12A	180W	74*74*32	300G/330G
5VDC-15VDC 15A	9~14VDC	15VDC	15A	225W	100*80*39	500G/550G
5VDC-15VDC 18A	10~14VDC	15VDC	18A	270W	100*80*39	500G/550G
5VDC-15VDC 20A	10~14VDC	15VDC	20A	300W	100*80*39	500G/550G

#### 6VDC-12VDC(1~20A)

Specification	Input Voltage VDC Range	Output Volts VDC	DC Output Current AMP	Max Power WATT	Size (MM) L*H*W	NW/GW (G)
6VDC-12VDC 1A	5~11VDC	12VDC	1A	12W	58*40*22	100G/125G
6VDC-12VDC 1A	5~11VDC	12VDC	1A	12W	66*57*22	100G/125G
6VDC-12VDC 2A	5~11VDC	12VDC	2A	24W	58*40*22	100G/125G
6VDC-12VDC 2A	5~11VDC	12VDC	2A	24W	66*57*22	100G/125G
6VDC-12VDC 3A	5~11VDC	12VDC	3A	36W	58*40*22	100G/125G
6VDC-12VDC 3A	5~11VDC	12VDC	3A	36W	66*57*22	100G/125G
6VDC-12VDC 4A	5~11VDC	12VDC	4A	48W	58*40*22	100G/125G
6VDC-12VDC 5A	5~11VDC	12VDC	5A	60W	74*74*32	300G/330G
6VDC-12VDC 6A	5~11VDC	12VDC	6A	72W	74*74*32	300G/330G
6VDC-12VDC 8A	5~11VDC	12VDC	8A	96W	74*74*32	300G/330G
6VDC-12VDC 10A	6~11VDC	12VDC	10A	120W	74*74*32	300G/330G
6VDC-12VDC 12A	6~11VDC	12VDC	12A	144W	74*74*32	300G/330G
6VDC-12VDC 15A	6~11VDC	12VDC	15A	180W	125*105*52	1000G/1250G
6VDC-12VDC 20A	6~11VDC	12VDC	20A	240W	125*105*52	1000G/1250G

#### 12VDC-13.8VDC(1~12A)

Specification	Input Voltage VDC Range	Output Volts VDC	DC Output Current AMP	Max Power WATT	Size (MM) L*H*W	NW/GW (G)
---------------	----------------------------	---------------------	--------------------------	-------------------	--------------------	--------------

12VDC-13.8VDC 1A	9~13VDC	13.8VDC	1A	13.8W	58*40*22	100G/125G
12VDC-13.8VDC 1A	9~13VDC	13.8VDC	1A	13.8W	66*57*22	100G/125G
12VDC-13.8VDC 2A	9~13VDC	13.8VDC	2A	27.6W	58*40*22	100G/125G
12VDC-13.8VDC 2A	9~13VDC	13.8VDC	2A	27.6W	66*57*22	100G/125G
12VDC-13.8VDC 3A	9~13VDC	13.8VDC	3A	41.4W	58*40*22	100G/125G
12VDC-13.8VDC 3A	9~13VDC	13.8VDC	3A	41.4W	66*57*22	100G/125G
12VDC-13.8VDC 3A	9~13VDC	13.8VDC	3A	41.4W	74*74*32	300G/330G
12VDC-13.8VDC 4A	9~13VDC	13.8VDC	4A	55.2W	58*40*22	100G/125G
12VDC-13.8VDC 4A	9~13VDC	13.8VDC	4A	55.2W	74*74*32	300G/330G
12VDC-13.8VDC 5A	9~13VDC	13.8VDC	5A	69W	74*74*32	300G/330G
12VDC-13.8VDC 6A	9~13VDC	13.8VDC	6A	82.8W	74*74*32	300G/330G
12VDC-13.8VDC 8A	9~13VDC	13.8VDC	8A	100.8W	74*74*32	300G/330G
12VDC-13.8VDC 10A	9~13VDC	13.8VDC	10A	138W	74*74*32	300G/330G
12VDC-13.8VDC 12A	9~13VDC	13.8VDC	12A	165.6W	74*74*32	300G/330G

12VDC-15VDC(1~12A)						
Specification	Input Voltage VDC Range	Output Volts VDC	DC Output Current AMP	Max Power WATT	Size (MM) L*H*W	NW/GW (G)
12VDC-15VDC 1A	9~14VDC	15VDC	1A	15W	58*40*22	100G/125G
12VDC-15VDC 1A	9~14VDC	15VDC	1A	15W	66*57*22	100G/125G
12VDC-15VDC 2A	9~14VDC	15VDC	2A	30W	58*40*22	100G/125G
12VDC-15VDC 2A	9~14VDC	15VDC	2A	30W	66*57*22	100G/125G
12VDC-15VDC 3A	9~14VDC	15VDC	3A	45W	58*40*22	100G/125G
12VDC-15VDC 3A	9~14VDC	15VDC	3A	45W	66*57*22	100G/125G
12VDC-15VDC 3A	9~14VDC	15VDC	3A	45W	74*74*32	300G/330G
12VDC-15VDC 4A	9~14VDC	15VDC	4A	60W	58*40*22	100G/125G
12VDC-15VDC 4A	9~14VDC	15VDC	4A	60W	74*74*32	300G/330G
12VDC-15VDC 5A	9~14VDC	15VDC	5A	75W	74*74*32	300G/330G
12VDC-15VDC 6A	9~14VDC	15VDC	6A	90W	74*74*32	300G/330G
12VDC-15VDC 8A	9~14VDC	15VDC	8A	120W	74*74*32	300G/330G
12VDC-15VDC 10A	9~14VDC	15VDC	10A	150W	74*74*32	300G/330G
12VDC-15VDC 12A	9~14VDC	15VDC	12A	180W	74*74*32	300G/330G

12VDC-19VDC (1~20A)						
Specification	Input Voltage VDC Range	Output Volts VDC	DC Output Current AMP	Max Power WATT	Size (MM) L*H*W	NW/GW (G)
12VDC-19VDC 1A	9~16VDC	19VDC	1A	19W	66*57*22	100G/125G
12VDC-19VDC 2A	9~14VDC	19VDC	2A	38W	66*57*22	100G/125G
12VDC-19VDC 3A	9~16VDC	19VDC	3A	57W	66*57*22	100G/125G
12VDC-19VDC 4A	9~16VDC	19VDC	4A	76W	74*74*32	300G/330G
12VDC-19VDC 5A	9~16VDC	19VDC	5A	95W	74*74*32	300G/330G
12VDC-19VDC 6A	9~16VDC	19VDC	6A	114W	74*74*32	300G/330G
12VDC-19VDC 8A	9~16VDC	19VDC	8A	152W	74*74*32	300G/330G
12VDC-19VDC 10A	9~16VDC	19VDC	10A	190W	74*74*32	300G/330G

12VDC-19VDC 12A	9~16VDC	19VDC	12A	228W	74*74*32	300G/330G
12VDC-19VDC 15A	10~15VDC	19VDC	15A	285W	100*80*39	500G/550G
12VDC-19VDC 18A	10~15VDC	19VDC	18A	342W	100*80*39	500G/550G
12VDC-19VDC 20A	10~15VDC	19VDC	20A	380W	100*80*39	500G/550G

12VDC-24VDC (1~100A)						
Specification	Input Voltage VDC Range	Output Volts VDC	DC Output Current AMP	Max Power WATT	Size (MM) L*H*W	NW/GW (G)
12VDC-24VDC 1A	9~20VDC	24VDC	1A	24W	58*40*22	100G/125G
12VDC-24VDC 1A	9~20VDC	24VDC	1A	24W	66*57*22	100G/125G
12VDC-24VDC 2A	9~20VDC	24VDC	2A	48W	58*40*22	100G/125G
12VDC-24VDC 2A	9~20VDC	24VDC	2A	48W	66*57*22	100G/125G
12VDC-24VDC 3A	9~20VDC	24VDC	3A	72W	58*40*22	100G/125G
12VDC-24VDC 3A	9~20VDC	24VDC	3A	72W	66*57*22	100G/125G
12VDC-24VDC 3A	9~20VDC	24VDC	3A	72W	74*74*32	300G/330G
12VDC-24VDC 4A	9~20VDC	24VDC	4A	96W	58*40*22	100G/125G
12VDC-24VDC 4A	9~20VDC	24VDC	4A	96W	74*74*32	300G/330G
12VDC-24VDC 5A	9~20VDC	24VDC	5A	120W	74*74*32	300G/330G
12VDC-24VDC 6A	9~20VDC	24VDC	6A	144W	74*74*32	300G/330G
12VDC-24VDC 8A	9~20VDC	24VDC	8A	192W	74*74*32	300G/330G
12VDC-24VDC 10A	9~20VDC	24VDC	10A	240W	74*74*32	300G/330G
12VDC-24VDC 12A	9~20VDC	24VDC	12A	288W	74*74*32	300G/330G
12VDC-24VDC 15A	10~15VDC	24VDC	15A	360W	100*80*39	500G/550G
12VDC-24VDC 18A	10~15VDC	24VDC	18A	432W	100*80*39	500G/550G
12VDC-24VDC 20A	10~15VDC	24VDC	20A	480W	100*80*39	500G/550G
12VDC-24VDC 30A	10~15VDC	24VDC	30A	720W	150*127*63	1600G/1800G
12VDC-24VDC 40A	10~15VDC	24VDC	40A	960W	180*127*63	1800G/2000G
12VDC-24VDC 50A	10~15VDC	24VDC	50A	1200W	220*127*63	2500G/3000G
12VDC-24VDC 60A	10~15VDC	24VDC	60A	1440W	220*130*50	2500G/3000G
12VDC-24VDC 80A	10~15VDC	24VDC	80A	1920W	300*198*80	6000G/7000G
12VDC-24VDC 100A	10~15VDC	24VDC	100A	2400W	300*198*80	6000G/7000G

12VDC-28VDC (1~100A)						
Specification	Input Voltage VDC Range	Output Volts VDC	DC Output Current AMP	Max Power WATT	Size (MM) L*H*W	NW/GW (G)
12VDC-28VDC 1A	9~16VDC	28VDC	1A	28W	66*57*22	100G/125G
12VDC-28VDC 2A	9~16VDC	28VDC	2A	56W	66*57*22	100G/125G
12VDC-28VDC 3A	9~16VDC	28VDC	3A	84W	66*57*22	100G/125G
12VDC-28VDC 4A	9~16VDC	28VDC	4A	112W	74*74*32	300G/330G
12VDC-28VDC 5A	9~16VDC	28VDC	5A	140W	74*74*32	300G/330G
12VDC-28VDC 6A	9~16VDC	28VDC	6A	168W	74*74*32	300G/330G
12VDC-28VDC 8A	9~16VDC	28VDC	8A	224W	74*74*32	300G/330G
12VDC-28VDC 10A	9~16VDC	28VDC	10A	280W	74*74*32	300G/330G
12VDC-28VDC 15A	10~15VDC	28VDC	15A	420W	100*80*39	500G/550G

12VDC-28VDC 20A	10~15VDC	28VDC	20A	560W	150*127*63	1600G/1800G
12VDC-28VDC 25A	10~15VDC	28VDC	25A	700W	180*127*63	1800G/2000G
12VDC-28VDC 30A	10~15VDC	28VDC	30A	840W	180*127*63	1800G/2000G
12VDC-28VDC 40A	10~15VDC	28VDC	40A	1120W	220*127*63	2500G/3000G
12VDC-28VDC 50A	10~15VDC	28VDC	50A	1440W	220*127*63	2500G/3000G
12VDC-28VDC 60A	10~15VDC	28VDC	60A	1680W	220*156*65	3700G/4500G
12VDC-28VDC 80A	10~15VDC	28VDC	80A	2240W	280*150*65	3000G/3200G
12VDC-28VDC 100A	10~15VDC	28VDC	100A	2800W	300*195*90	6000G/7000G
12VDC-28VDC 150A	10~15VDC	28VDC	150A	4200W	320*156*65	6000G/7000G

#### 12VDC-36VDC (1~40A)

Specification	Input Voltage VDC Range	Output Volts VDC	DC Output Current AMP	Max Power WATT	Size (MM) L*H*W	NW/GW (G)
12VDC-36VDC 1A	10~15VDC	36VDC	1A	36W	66*57*22	100G/125G
12VDC-36VDC 1A	9~20VDC	36VDC	1A	36W	74*74*32	300G/330G
12VDC-36VDC 2A	10~15VDC	36VDC	2A	72W	66*57*22	100G/125G
12VDC-36VDC 2A	9~20VDC	36VDC	2A	72W	74*74*32	300G/330G
12VDC-36VDC 3A	9~20VDC	36VDC	3A	108W	74*74*32	300G/330G
12VDC-36VDC 4A	9~20VDC	36VDC	4A	144W	74*74*32	300G/330G
12VDC-36VDC 5A	9~20VDC	36VDC	5A	180W	74*74*32	300G/330G
12VDC-36VDC 6A	9~20VDC	36VDC	6A	216W	74*74*32	300G/330G
12VDC-36VDC 8A	9~20VDC	36VDC	8A	288W	74*74*32	300G/330G
12VDC-36VDC 10A	10~15VDC	36VDC	10A	360W	100*80*39	500G/550G
12VDC-36VDC 20A	10~15VDC	36VDC	20A	720W	150*127*63	1600G/1800G
12VDC-36VDC 30A	10~15VDC	36VDC	30A	1080W	220*127*63	2500G/3000G
12VDC-36VDC 40A	10~25VDC	36VDC	40A	1440W	220*127*63	2500G/3000G

#### 12VDC-48VDC (1~40A)

Specification	Input Voltage VDC Range	Output Volts VDC	DC Output Current AMP	Max Power WATT	Size (MM) L*H*W	NW/GW (G)
12VDC-48VDC 1A	10~20VDC	48VDC	1A	48W	74*74*32	300G/330G
12VDC-48VDC 2A	10~20VDC	48VDC	2A	96W	74*74*32	300G/330G
12VDC-48VDC 3A	10~20VDC	48VDC	3A	144W	74*74*32	300G/330G
12VDC-48VDC 4A	10~20VDC	48VDC	4A	192W	74*74*32	300G/330G
12VDC-48VDC 5A	10~20VDC	48VDC	5A	240W	74*74*32	300G/330G
12VDC-48VDC 6A	10~20VDC	48VDC	6A	288W	74*74*32	300G/330G
12VDC-48VDC 8A	10~16VDC	48VDC	8A	384W	125*105*52	1000G/1250G
12VDC-48VDC 8A	10~16VDC	48VDC	8A	384W	100*113*35	700G/900G
12VDC-48VDC 10A	10~16VDC	48VDC	10A	480W	125*105*52	1000G/1250G
12VDC-48VDC 10A	10~16VDC	48VDC	10A	480W	100*113*35	700G/900G
12VDC-48VDC 15A	10~16VDC	48VDC	15A	720W	150*127*63	1600G/1800G
12VDC-48VDC 20A	10~16VDC	48VDC	20A	960W	220*127*63	2500G/3000G
12VDC-48VDC 30A	10~16VDC	48VDC	30A	1440W	220*127*63	2500G/3000G
12VDC-48VDC 40A	10~16VDC	48VDC	40A	1920W	220*156*65	3700G/4500G

12VDC-56VDC/56.4VDC (1~8A)

Specification	Input Voltage VDC Range	Output Volts VDC	DC Output Current AMP	Max Power WATT	Size (MM) L*H*W	NW/GW (G)
12VDC-56VDC 1A	10~20VDC	56VDC	1A	56W	74*74*32	300G/330G
12VDC-56VDC 2A	10~20VDC	56VDC	2A	112W	74*74*32	300G/330G
12VDC-56VDC 3A	10~20VDC	56VDC	3A	168W	74*74*32	300G/330G
12VDC-56VDC 4A	10~20VDC	56VDC	4A	224W	74*74*32	300G/330G
12VDC-56VDC 5A	10~20VDC	56VDC	5A	280W	125*105*52	1000G/1250G
12VDC-56VDC 6A	10~20VDC	56VDC	6A	336W	125*105*52	1000G/1250G
12VDC-56VDC 8A	10~20VDC	56VDC	8A	448W	125*105*52	1000G/1250G
12VDC-56.4VDC 20A	10~16VDC	56.4VDC	20A	1128W	220*130*50	2500G/3000G
12VDC-56.4VDC 30A	10~16VDC	56.4VDC	30A	1692W	220*156*65	3700G/4500G

12VDC-60VDC (1~3A)

Specification	Input Voltage VDC Range	Output Volts VDC	DC Output Current AMP	Max Power WATT	Size (MM) L*H*W	NW/GW (G)
12VDC-60VDC 1A	10~20VDC	60VDC	1A	60W	74*74*32	300G/330G
12VDC-60VDC 2A	10~20VDC	60VDC	2A	120W	74*74*32	300G/330G
12VDC-60VDC 3A	10~20VDC	60VDC	3A	180W	74*74*32	300G/330G

24VDC-48VDC (1~60A)

Specification	Input Voltage VDC Range	Output Volts VDC	DC Output Current AMP	Max Power WATT	Size (MM) L*H*W	NW/GW (G)
24VDC-48VDC 1A	15~30VDC	48VDC	1A	48W	74*74*32	300G/330G
24VDC-48VDC 2A	15~30VDC	48VDC	2A	96W	74*74*32	300G/330G
24VDC-48VDC 3A	15~30VDC	48VDC	3A	144W	74*74*32	300G/330G
24VDC-48VDC 4A	15~30VDC	48VDC	4A	192W	74*74*32	300G/330G
24VDC-48VDC 5A	15~30VDC	48VDC	5A	240W	74*74*32	300G/330G
24VDC-48VDC 6A	15~30VDC	48VDC	6A	288W	74*74*32	300G/330G
24VDC-48VDC 8A	20~40VDC	48VDC	8A	384W	100*80*39	500G/550G
24VDC-48VDC 10A	20~40VDC	48VDC	10A	480W	100*80*39	500G/550G
24VDC-48VDC 12A	20~40VDC	48VDC	12A	576W	100*80*39	500G/550G
24VDC-48VDC 15A	20~40VDC	48VDC	15A	720W	100*80*39	500G/550G
24VDC-48VDC 20A	20~40VDC	48VDC	20A	960W	100*80*39	500G/550G
24VDC-48VDC 30A	20~40VDC	48VDC	30A	1440W	150*127*63	1600G/1800G
24VDC-48VDC 40A	20~40VDC	48VDC	40A	1920W	220*127*63	2500G/3000G
24VDC-48VDC 50A	20~40VDC	48VDC	50A	2400W	300*127*63	3500G/4000G
24VDC-48VDC 60A	20~40VDC	48VDC	60A	2880W	300*127*63	3500G/4000G

24VDC-72VDC (1~40A)

Specification	Input Voltage VDC Range	Output Volts VDC	DC Output Current AMP	Max Power WATT	Size (MM) L*H*W	NW/GW (G)
24VDC-72VDC 1A	15~30VDC	72VDC	1A	72W	100*113*35	700G/900G
24VDC-72VDC 2A	15~30VDC	72VDC	2A	144W	100*113*35	700G/900G



24VDC-72VDC 3A	15~30VDC	72VDC	3A	216W	100*113*35	700G/900G
24VDC-72VDC 4A	15~30VDC	72VDC	4A	288W	100*113*35	700G/900G
24VDC-72VDC 5A	15~30VDC	72VDC	5A	360W	100*113*35	700G/900G
24VDC-72VDC 20A	15~30VDC	72VDC	20A	1440W	220*156*65	3700G/4500G
24VDC-72VDC 30A	15~30VDC	72VDC	30A	2160W	220*156*65	3700G/4500G
24VDC-72VDC 40A	15~30VDC	72VDC	40A	2880W	300*195*90	6000G/7000G

48VDC-72VDC (30~45A)						
Specification	Input Voltage VDC Range	Output Volts VDC	DC Output Current AMP	Max Power WATT	Size (MM) L*H*W	NW/GW (G)
48VDC-72VDC 30A	40~60VDC	72VDC	30A	2160W	220*130*50	2500G/3000G
48VDC-72VDC 40A	40~60VDC	72VDC	40A	2880W	220*156*65	3700G/4500G
48VDC-72VDC 45A	40~60VDC	72VDC	45A	3240W	220*156*65	3700G/4500G

(6~20VDC)12VDC-12VDC(1~30A)						
Specification	Input Voltage VDC Range	Output Volts VDC	DC Output Current AMP	Max Power WATT	Size (MM) L*H*W	NW/GW (G)
12VDC-12VDC 1A	6~20VDC	12VDC	1A	12W	58*40*22	100G/125G
12VDC-12VDC 2A	6~20VDC	12VDC	2A	24W	58*40*22	100G/125G
12VDC-12VDC 3A	6~20VDC	12VDC	3A	36W	58*40*22	100G/125G
12VDC-12VDC 3A	6~20VDC	12VDC	3A	36W	74*74*32	300G/330G
12VDC-12VDC 4A	6~20VDC	12VDC	4A	48W	74*74*32	300G/330G
12VDC-12VDC 5A	6~20VDC	12VDC	5A	60W	74*74*32	300G/330G
12VDC-12VDC 6A	6~20VDC	12VDC	6A	72W	74*74*32	300G/330G
12VDC-12VDC 8A	6~20VDC	12VDC	8A	96W	74*74*32	300G/330G
12VDC-12VDC 10A	6~20VDC	12VDC	10A	120W	74*74*32	300G/330G
12VDC-12VDC 12A	6~20VDC	12VDC	12A	144W	74*74*32	300G/330G

### Boost & Step Down Non Isolate DC DC Converter Model List

(8~40VDC)12VDC/24VDC-12VDC(1~30A)						
Specification	Input Voltage VDC Range	Output Volts VDC	DC Output Current AMP	Max Power WATT	Size (MM) L*H*W	NW/GW (G)
12VDC/24VDC-12VDC 1A	8~40VDC	12VDC	1A	12W	66*57*22	100G/125G
12VDC/24VDC-12VDC 2A	8~40VDC	12VDC	2A	24W	66*57*22	100G/125G
12VDC/24VDC-12VDC 3A	8~40VDC	12VDC	3A	36W	66*57*22	100G/125G
12VDC/24VDC-12VDC 5A	8~40VDC	12VDC	5A	60W	74*74*32	300G/330G
12VDC/24VDC-12VDC 10A	8~40VDC	12VDC	10A	120W	74*74*32	300G/330G
12VDC/24VDC-12VDC 15A	8~40VDC	12VDC	15A	180W	100*80*38	500G/550G
12VDC/24VDC-12VDC 20A	8~40VDC	12VDC	20A	240W	100*80*38	500G/550G
12VDC/24VDC-12VDC 25A	8~40VDC	12VDC	25A	300W	100*80*38	500G/550G
12VDC/24VDC-12VDC 30A	8~40VDC	12VDC	30A	360W	220*130*50	2500G/3000G

## (9~36VDC)12VDC/24VDC-12.6VDC(1~20A) ---Lithium Battery Charging

Specification	Input Voltage VDC Range	Output Volts VDC	DC Output Current AMP	Max Power WATT	Size (MM) L*H*W	NW/GW (G)
12VDC/24VDC-12.6VDC 3A	9~36VDC	12.6VDC	3A	12.6W	74*74*32	300G/330G
12VDC/24VDC-12.6VDC 5A	9~36VDC	12.6VDC	5A	63W	74*74*32	300G/330G
12VDC/24VDC-12.6VDC 6A	9~36VDC	12.6VDC	6A	75.6W	74*74*32	300G/330G
12VDC/24VDC-12.6VDC 8A	9~36VDC	12.6VDC	8A	100.8W	74*74*32	300G/330G
12VDC/24VDC-12.6VDC 10A	9~36VDC	12.6VDC	10A	126W	74*74*32	300G/330G
12VDC/24VDC-12.6VDC 20A	9~36VDC	12.6VDC	20A	252W	100*80*38	500G/550G

## (6~20VDC)12VDC-13.8VDC(1~30A)

Specification	Input Voltage VDC Range	Output Volts VDC	DC Output Current AMP	Max Power WATT	Size (MM) L*H*W	NW/GW (G)
12VDC-13.8VDC 1A	6~20VDC	13.8VDC	1A	13.8W	58*40*22	100G/125G
12VDC-13.8VDC 2A	6~20VDC	13.8VDC	2A	27.6W	58*40*22	100G/125G
12VDC-13.8VDC 3A	6~20VDC	13.8VDC	3A	41.4W	58*40*22	100G/125G
12VDC-13.8VDC 3A	6~20VDC	13.8VDC	3A	41.4W	74*74*32	300G/330G
12VDC-13.8VDC 4A	6~20VDC	13.8VDC	4A	55.2W	74*74*32	300G/330G
12VDC-13.8VDC 5A	6~20VDC	13.8VDC	5A	69W	74*74*32	300G/330G
12VDC-13.8VDC 6A	6~20VDC	13.8VDC	6A	110.4W	74*74*32	300G/330G
12VDC-13.8VDC 8A	6~20VDC	13.8VDC	8A	110.4W	74*74*32	300G/330G
12VDC-13.8VDC 10A	6~20VDC	13.8VDC	10A	138W	74*74*32	300G/330G
12VDC-13.8VDC 12A	6~20VDC	12VDC	12A	165.6W	74*74*32	300G/330G

## (8~40VDC)12VDC/24VDC-13.8VDC(1~30A)

Specification	Input Voltage VDC Range	Output Volts VDC	DC Output Current AMP	Max Power WATT	Size (MM) L*H*W	NW/GW (G)
12VDC/24VDC-13.8VDC 1A	8~40VDC	13.8VDC	1A	13.8W	66*57*22	100G/125G
12VDC/24VDC-13.8VDC 2A	8~40VDC	13.8VDC	2A	27.6W	66*57*22	100G/125G
12VDC/24VDC-13.8VDC 3A	8~40VDC	13.8VDC	3A	41.4W	66*57*22	100G/125G
12VDC/24VDC-13.8VDC 5A	8~40VDC	13.8VDC	5A	69W	74*74*32	300G/330G
12VDC/24VDC-13.8VDC 10A	8~40VDC	13.8VDC	10A	120W	74*74*32	300G/330G
12VDC/24VDC-13.8VDC 15A	8~40VDC	13.8VDC	15A	207W	100*80*38	500G/550G
12VDC/24VDC-13.8VDC 20A	8~40VDC	13.8VDC	20A	276W	100*80*38	500G/550G
12VDC/24VDC-13.8VDC 25A	8~40VDC	13.8VDC	25A	345W	100*80*38	500G/550G
12VDC/24VDC-13.8VDC 30A	8~40VDC	13.8VDC	30A	414W	220*130*50	2500G/3000G

## (8~36VDC)12VDC/24VDC-13.8VDC(8A &amp; 20A) Battery Charging

Specification	Input Voltage VDC Range	Output Volts VDC	DC Output Current AMP	Max Power WATT	Size (MM) L*H*W	NW/GW (G)
12VDC/24VDC-13.8VDC 8A	8~36VDC	13.8VDC	8A	110.4W	74*74*32	300G/330G
12VDC/24VDC-13.8VDC 20A	8~36VDC	13.8VDC	20A	276W	100*80*38	500G/550G

## (8~30VDC)12VDC/24VDC-14.6VDC(3A 8A 12A) Battery Charging

Specification	Input Voltage VDC Range	Output Volts VDC	DC Output Current AMP	Max Power WATT	Size (MM) L*H*W	NW/GW (G)
12VDC/24VDC-14.6VDC 3A	8~30VDC	14.6VDC	3A	43.8W	78*56*22	700G/1200G
12VDC/24VDC-14.6VDC 8A	8~30VDC	14.6VDC	8A	116.8W	118*80*28	1500G/2000G
12VDC/24VDC-14.6VDC 12A	8~30VDC	14.6VDC	12A	175.2W	180*118*39	2000G/2500G

## (9~36VDC)12VDC/24VDC-19VDC(1~15A)

Specification	Input Voltage VDC Range	Output Volts VDC	DC Output Current AMP	Max Power WATT	Size (MM) L*H*W	NW/GW (G)
12VDC/24VDC-19VDC 1A	9~36VDC	19VDC	1A	19W	58*40*22	100G/125G
12VDC/24VDC-19VDC 2A	9~36VDC	19VDC	2A	38W	66*57*22	100G/125G
12VDC/24VDC-19VDC 3A	9~36VDC	19VDC	3A	57W	66*57*22	100G/125G
12VDC/24VDC-19VDC 3A	9~36VDC	19VDC	3A	57W	74*74*32	300G/330G
12VDC/24VDC-19VDC 5A	9~36VDC	19VDC	5A	95W	74*74*32	300G/330G
12VDC/24VDC-19VDC 6A	9~36VDC	19VDC	6A	114W	74*74*32	300G/330G
12VDC/24VDC-19VDC 8A	9~36VDC	19VDC	8A	152W	74*74*32	300G/330G
12VDC/24VDC-19VDC 10A	9~36VDC	19VDC	10A	190W	100*80*38	500G/550G
12VDC/24VDC-19VDC 15A	9~36VDC	19VDC	15A	285W	100*80*38	500G/550G

## (8~40VDC)12VDC/24VDC-24VDC(1~20A)

Specification	Input Voltage VDC Range	Output Volts VDC	DC Output Current AMP	Max Power WATT	Size (MM) L*H*W	NW/GW (G)
12VDC/24VDC-24VDC 1A	8~40VDC	24VDC	1A	24W	58*40*22	100G/125G
12VDC/24VDC-24VDC 2A	8~40VDC	24VDC	2A	48W	66*57*22	100G/125G
12VDC/24VDC-24VDC 3A	8~40VDC	24VDC	3A	72W	66*57*22	100G/125G
12VDC/24VDC-24VDC 3A	8~40VDC	24VDC	3A	72W	74*74*32	300G/330G
12VDC/24VDC-24VDC 5A	8~40VDC	24VDC	5A	120W	74*74*32	300G/330G
12VDC/24VDC-24VDC 6A	8~40VDC	24VDC	6A	144W	74*74*32	300G/330G
12VDC/24VDC-24VDC 8A	8~40VDC	24VDC	8A	192W	74*74*32	300G/330G
12VDC/24VDC-24VDC 10A	8~40VDC	24VDC	10A	240W	100*80*38	500G/550G
12VDC/24VDC-24VDC 15A	8~40VDC	24VDC	15A	360W	100*80*38	500G/550G

## (18~36VDC)24VDC-24VDC(1~20A)

Specification	Input Voltage VDC Range	Output Volts VDC	DC Output Current AMP	Max Power WATT	Size (MM) L*H*W	NW/GW (G)
24VDC-24VDC 1A	18~36VDC	24VDC	1A	24W	58*40*22	100G/125G
24VDC-24VDC 2A	18~36VDC	24VDC	2A	48W	66*57*22	100G/125G
24VDC-24VDC 3A	18~36VDC	24VDC	3A	72W	66*57*22	100G/125G
24VDC-24VDC 5A	18~36VDC	24VDC	5A	120W	74*74*32	300G/330G
24VDC-24VDC 6A	18~36VDC	24VDC	6A	144W	74*74*32	300G/330G
24VDC-24VDC 8A	18~36VDC	24VDC	8A	192W	74*74*32	300G/330G
24VDC-24VDC 10A	18~36VDC	24VDC	10A	240W	74*74*32	300G/330G
24VDC-24VDC 12A	18~36VDC	24VDC	12A	144W	100*80*38	500G/550G

24VDC-24VDC 15A	18~36VDC	24VDC	15A	360W	100*80*38	500G/550G
24VDC-24VDC 20A	18~36VDC	24VDC	20A	480W	125*105*52	1000G/1250G

(9~36VDC & 18~36VDC)12/24VDC-27VDC 8A &20A) Lithium Battery Charging

Specification	Input Voltage VDC Range	Output Volts VDC	DC Output Current AMP	Max Power WATT	Size (MM) L*H*W	NW/GW (G)
12VDC/24VDC-27VDC 8A	9~36VDC	27VDC	8A	216W	100*80*38	550G/600G
24VDC-27VDC 20A	18~36VDC	27VDC	20A	540W	100*80*38	550G/600G

(9~36VDC & 18~36VDC)12/24VDC-28VDC 8A &20A) Battery Charging

Specification	Input Voltage VDC Range	Output Volts VDC	DC Output Current AMP	Max Power WATT	Size (MM) L*H*W	NW/GW (G)
12VDC/24VDC-28VDC 8A	9~36VDC	28VDC	8A	216W	100*80*38	550G/600G
24VDC-28VDC 20A	18~36VDC	28VDC	20A	560W	100*80*38	550G/600G

IDEAL PLUSING

# 04

## Non Standard Customized

---

*IDEALPLUSING*

DC DC Converter

# Non Standard Customized

Wire length can be customized

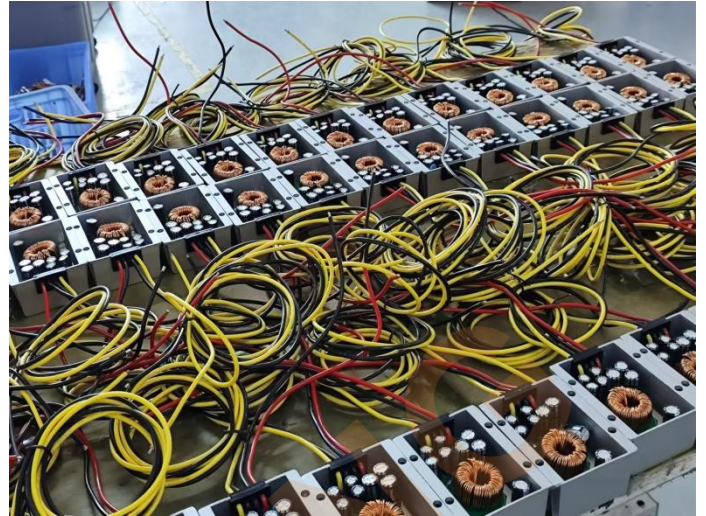
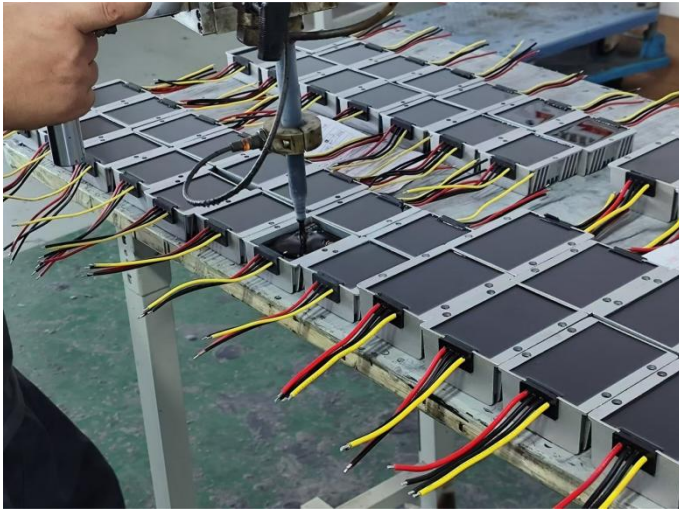

Wire interface can be customized

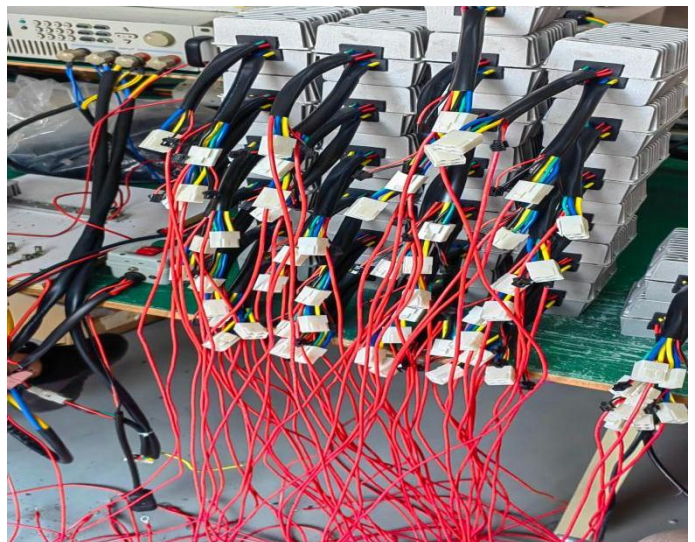
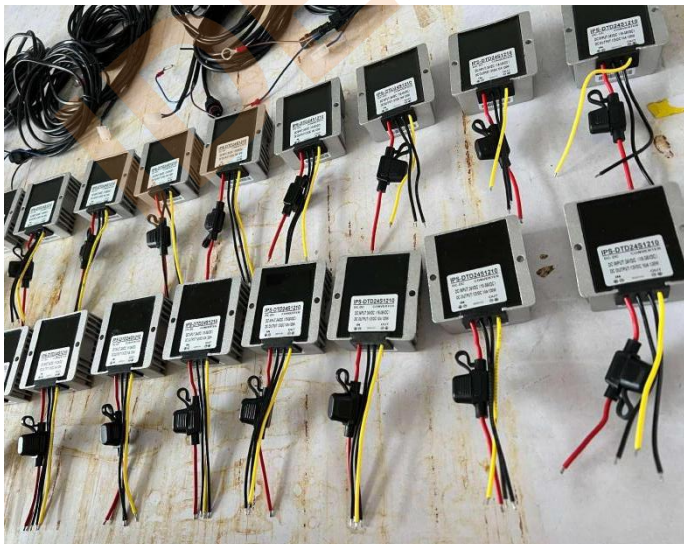
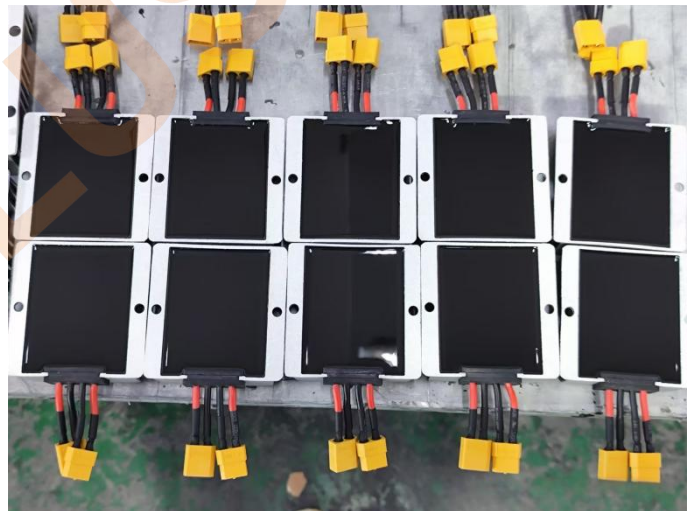

**Wire diameter and length can be customized**



**Any model can be customized**

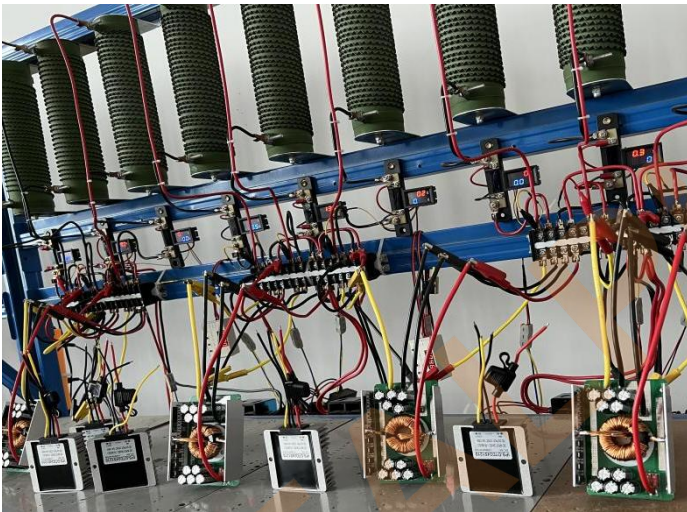

Customized products need to be tested on an aging test bench before they can be shipped.

# Different shell customization





# 05

## Product Wiring

---

*IDEALPLUSING*

DC DC Converter

# Product Wiring

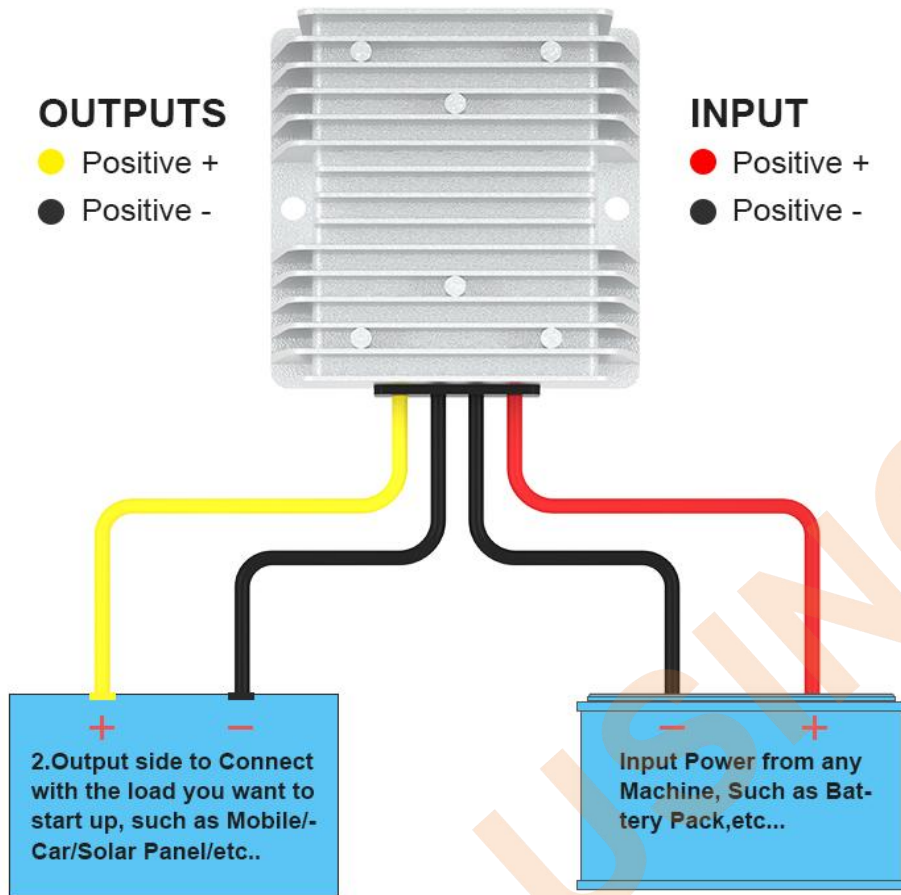

**Notice:**

1. Please provide the exact voltage of converter that the electrical appliance require.
2. Power should not be greater than the power that the converter can withstand.
3. The output positive and negative poles can not be connected with each other.

**Notice:**

1. The voltage fluctuation range of the power supply should not exceed the voltage range that the converter can withstand.
2. The power of the power supply must be greater than the power required for the use of electrical appliances.
3. Input positive and negative poles can not be reversed!

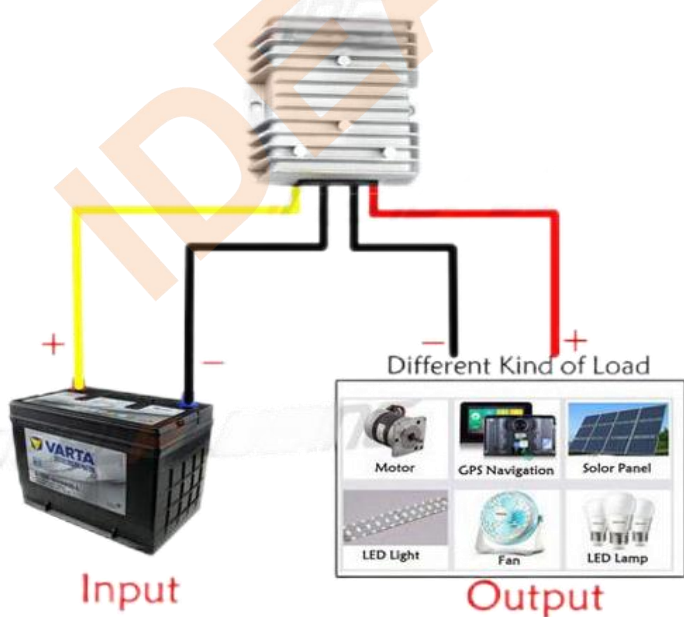

## Wiring Diagram

Tips: The positive and negative poles of the input and output cannot be reversed, otherwise the converter will be permanently damaged.

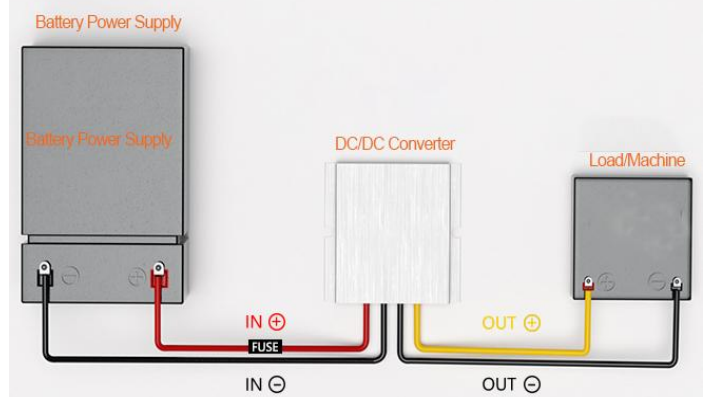

# 06

## Packaging and Shipping

---

*IDEALPLUSING*

DC DC Converter

# Packaging and Shipping



Single packing



Land transportation



Air transport (No magnet/Lithium free battery)



Carton packaging



Ocean shipping (Shock and moisture resistance)

# IIPS

**Mobile/WhatsApp:** +86-18928830209

**Tel:** +86-20-89282095 **Email:** info@idealplusing.com

**Website:** www.idealplusing.com www.azyps.com

www.idealpowersupply.com www.ybyps.com www.jmhvpower.com.com

**Office address:** 1st Floor, Building 1, No. 85 Gaopu Road, Tianhe District, Guangzhou



WhatsApp



Wechat

**IDEALPLUSING®**